

HX65A

TRACKED EXCAVATOR



Gross Power
48.5 kW (65.9 hp) at 2400 rpm

Bucket Capacity
0.07 to 0.18 m³

Operating Weight
6080 kg

 **HD HYUNDAI**

PRODUCTIVITY & PERFORMANCE

The highly efficient Stage V HD Hyundai engine enhances fuel efficiency yet still offers industry-leading performance, along with low noise and vibration. And thanks to its optimised design and counterweight, the HX65A has the best work stability in its class.

Greater efficiency

The new HD Hyundai engine increases fuel efficiency by 6% compared to the previous model, while having the highest torque in its class. And with a DOC + DPF installed, it doesn't need any extra additives.

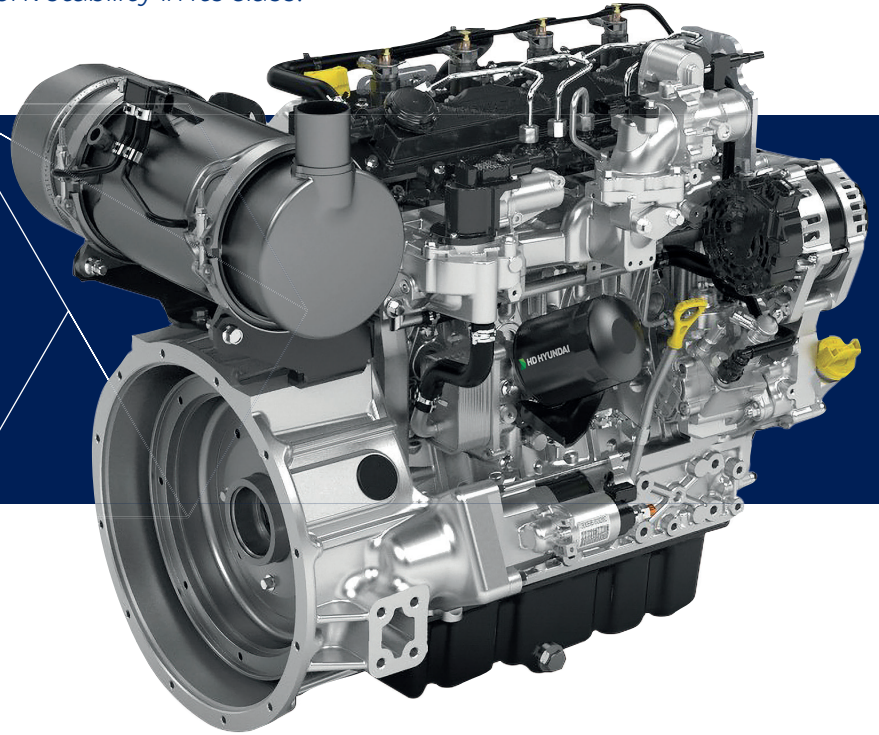

The high-powered Stage V HD Hyundai DM02V engine delivers 66 HP and peak torque of 248 Nm.



Optimal counterweight

Lifting force has been increased massively by installing a heavy counterweight. It also enables the best working stability in its class.

Improved engine cowl air vent

Increasing the vent hole of the engine cowl by 76% has improved engine cooling and durability and reduced noise.

Reinforced bushing application

Durability is enhanced by applying dimple bushing to the boom pin area.

A 4-way hydraulic line provides greater versatility for the operator allowing a greater use of attachments.

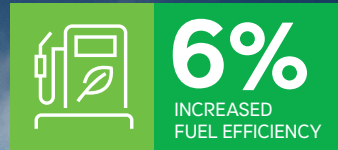

✔ Built for tough working

The HX65A is designed to withstand harsh treatment, increased thickness lower frame, wet track link, full track guards give maximum protection and durability.

Dozer, boom and engine hood guarding give extra protection.

✔ Powerful driving motor

Powerful track motors provide unrivaled performance and traction.

Complete durability

A double layer air cleaner blocks dust from the engine, which optimises the air filter replacement and the engine's durability.

Optimal hydraulic pipeline layout

The hydraulic pipes are placed at the top of the boom to prevent damage when working in narrow trenches.

Seamless performance ▶

By designing everything in-house, HD Hyundai has created the perfect synergy between engine and machine, with reduced noise and vibration enhancing operator comfort.



COMFORT & EASE OF USE

In the new HX65A, comfort and efficiency go hand in hand. The standard proportional joysticks improve operating while the new 7-inch touchscreen cluster makes diagnosing your machine as easy as possible. More space, better visibility and enhanced features make sure the operator enjoys a comfortable working environment.

Intelligent & wide cluster

The new layout increases the operator's comfort and productivity thanks to an increase in space, better visibility and new tools.

✔ New 7-inch touchscreen cluster

The new cluster maximises operator productivity by providing integrated, easy access to all necessary information, from the outside temperature to the power modes and hydraulics settings, on a highly readable screen.



Proportional joysticks **A**

The proportional joysticks as standard will greatly improve the operability of your machine and your attachments.

Smooth operation

A proven, high-quality RCV (Remote Control Valve) lever has been added to improve operating and let you personalise settings such as attachment control.

Bluetooth Radio **B**

Conveniently located radio with hands-free audio functions.



Comfort in all weathers

Standard air conditioning has been improved in the front and rear, while a 3-level, adjustable heated seat ensures maximum comfort.



Push button start

An innovative machine requires convenient modern functions like the button-type ignition key with start & stop function, plus added USB ports.

SAFETY

HD Hyundai excavators don't just meet the required safety standards, they exceed them. The HX65A includes multiple safety tools as standard like Auto safety locks on boom, arm and dozer blade cylinder, while a rear view camera ensures the safest working environment possible.

Max visibility

Visibility is key while working. That's why the HX65A can be optionally equipped with a rear-view camera.

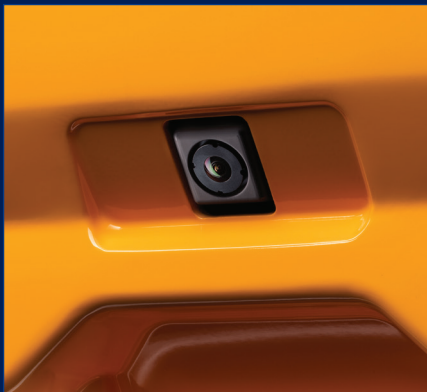

Rear-view camera for increased safety



LED lamps

For added safety, LED lamps are used in all the worklights with the boom worklights recessed to help prevent damage when working.

Seat belt warning alarm

If the seat belt is not buckled when the ignition key is turned, an alarm is sounded, along with a continuous visual alert.

Auto Safety Lock

The Auto Safety Lock prevents unintended operation due to the excavator not being controlled solely by the RCV lever.



SERVICEABILITY & TELEMATICS

The HX65A is designed to offer simple daily inspections of all major parts and quick, easy maintenance. All parts are accessible from ground level through extra wide opening cowl doors.

Reinforced Bushings

Dimple bushings on the boom pins reinforce durability and extend the grease-period of the machine.

Added Toolbox

Increased storage space with additional toolbox.

Double air cleaners

Dual air cleaners give increased filtration ensuring maximum engine life and long service intervals.

Optimal placement of filters

Large engine hood and easy ground level access to daily checks and filters.



Hi MATE

It's convenient, easy and valuable. Hi MATE, HD Hyundai's remote management system, utilises GPS-satellite technology to provide customers with the highest level of service and product support available.

Increase productivity

By providing information such as service hours, idle time and fuel consumption, Hi MATE saves you money and improves productivity. Service alerts enable better maintenance planning.

Monitor your machines

Hi MATE's real-time location information allows convenient monitoring of your equipment via the Hi MATE website or mobile app.

Improve Security

Protect your equipment from theft or unauthorised usage. Hi MATE's geofencing alerts notify you automatically when a machine leaves a predetermined zone.

Mobile fleet app

Our new mobile app provides all the information you need to run your equipment more efficiently and economically. It has been optimised for fleet management, providing health insights based on telematic technology to keep your machines working at maximum performance.



Keeping you covered

HD Hyundai Genuine Parts and accessories are designed to keep your machine running at optimum performance, with 24-hour delivery across our dealer network. HD Hyundai Standard and Extended Warranty Programmes provide peace of mind and give you full control over your operating costs.

HX65A

SPECIFICATIONS

SPECIFICATIONS	HX65A
ENGINE	
Maker / Model	HCE / DM02VB (D24)
Type	4-cycle, turbocharged, intercooled, electronic controlled diesel engine
Gross Power @ 2400 rpm	48.5 kW (65.9 hp)
Net Power @ 2400 rpm	47 kW (63.9 hp)
Max. Power @ 2400 rpm	48.5 kW (65.9 hp)
Peak Torque	248 N·m at 183 rpm
Displacement	2,392 ℓ
Starting Motor	12V x 2.5 kW
Alternator	13.5V-90A

HYDRAULIC SYSTEM	
Open Centre hydraulic system with two hydraulic pumps	
MAIN PUMP	
Type	Variable displacement tandem axial piston pumps
Max. flow	2 x 55 l/min
PILOT PUMP	
Type	Two gear pumps (pilot + swing, swivel, dozer)
Max. flow	38.4 + 9.5 l/min

HYDRAULIC MOTORS		
Travel	Two fixed displacement axial piston motors	
Swing	Fixed displacement axial piston motor	
RELIEF VALVE SETTING		
Implement circuits	220 kgf/cm ² (3130 psi)	
Travel	350 kgf/cm ² (4980 psi)	
Swing circuit	230 kgf/cm ² (3280 psi)	
Pilot circuit	30 kgf/cm ² (426 psi)	
HYDRAULIC CYLINDERS		
No. of cylinder bore x stroke	Boom:	1-110 x 715 mm
	Arm:	1-90 x 850 mm
	Bucket:	1-80 x 660 mm
	Blade:	2-110 x 224 mm

DRIVES & BRAKES	
Drive method	Fully Hydrostatic Type
Drive motor	Two Axial Piston Motors, In-Shoe Design
Reduction System	Planetary Reduction Gear
Max. Drawbar Pull	5,221 kgf
Max. Travel Speed (High / Low)	2.2 / 4.2 km/h
Gradeability	35° (70%)

CONTROLS	
Pilot pressure operated joysticks and pedals with detachable lever provide almost effortless and fatigueless operation.	
Pilot control	Two Joysticks with One Safety Lever (LH): Swing and Arm, (RH): Boom and Bucket
Traveling and Steering	Two Levers With Pedals
Engine throttle	Electric, Dial Type

SPECIFICATIONS	HX65A
SWING SYSTEM	
Swing motor	Fixed displacement axial piston motor
Swing reduction	2 - stage planetary
Swing bearing lubrication	Grease-Bathed
Swing brake	Multi wet disc
Swing speed	9.4 rpm

CAPACITIES	
	liter
Fuel tank	125
Engine coolant	11
Engine oil	8.6
Swing device	1.5
Final drive	1
Hydraulic system (including tank)	120
Hydraulic tank	70

UNDERCARRIAGE	
The X-leg type-center frame-is integrally welded with reinforced box section track frames. The undercarriage includes lubricated rollers, idlers, track adjusters with shock absorbing springs and sprockets, and a track chain with double or triple grouser shoes	
Centre frame	X-Leg type
Track frame	Pentagonal box type
No. of shoes on each side	76
No. of carrier roller	2 x 1
No. of track roller	2 x 5
Rail guard	Option for steel tracks

OPERATING WEIGHT (APPROXIMATE)				
Operating weight, including 3000 mm boom, 1600mm arm, SAE heaped 0.18 m ³ bucket, lubricant, coolant, full fuel tank, full hydraulic tank and all standard equipment.				
OPERATING WEIGHT				
Type	Shoe type	Shoe width	Operating weight	Ground pressure
HX65A	Rubber tracks	400 mm	6080 kg	0.35 kgf/cm ²
	Steel tracks w/rubber pads	400 mm	6460 kg	0.37 kgf/cm ²
	steel tracks	380 mm	6250 kg	0.38 kgf/cm ²

SOUND LEVEL	
Exterior sound level (EN474-1 : 2006 and 2000/14/EC) LWA	99 dB (EU only)
Interior sound level (EN474-1 : 2006 and 2000/14/EC) LPA	76 dB

AIR CONDITIONING SYSTEM	
The air conditioning system contains fluorinated greenhouse gas refrigerant R134a (Global Warming Potential = 1430). The system contains 0.65 kg of refrigerant representing a CO ₂ equivalent of 0.93 metric tonnes.	

DIGGING FORCE					
Boom	Length	mm	3000		
Arm	Length	mm	1600	1900	
		kN	37	37	
	Bucket digging force	SAE	kgf	3763	3763
			kN	42	42
ISO		kgf	4292	4292	
		kN	27	24	
Arm crowd force	SAE	kgf	2779	2476	
		kN	28	25	
	ISO	kgf	2886	2591	
		kN			

HX65A

DIMENSIONS & WORKING RANGE

HX65A MONO BOOM DIMENSIONS

3.0 Mono boom, 1.6m, 1.9m Arm, Front dozer

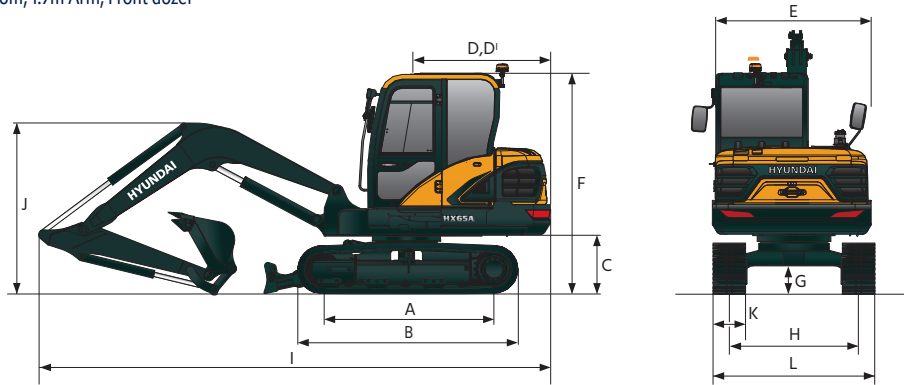

Unit: mm

A	Tumbler distance	2010
B	Overall length of crawler	2544
C	Ground clearance of upper structure	687
D	Tail swing radius	1650
D'	Rear-end length	1650
E	Overall width of upper structure	1850
F	Overall height of cab	1695
G	Min. Ground clearance	271
H	Track gauge	1500

	Boom length	3000	
	Arm length	1600	1900
I	Overall length	5995	5970
J	Overall height of boom	2595	2595

K	Track shoe width	400	400
L	Overall width	1900	1900

HX65A WORKING RANGE

Unit: mm

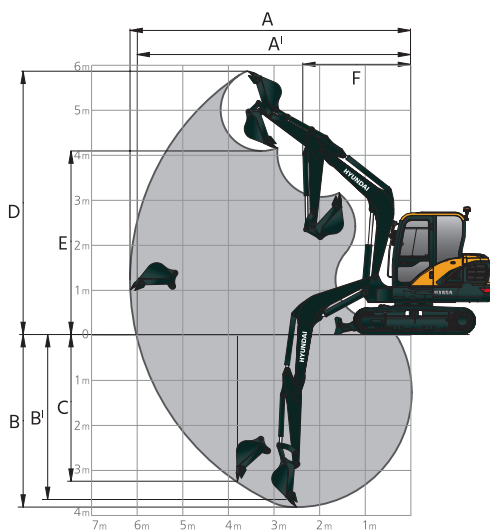

	Boom length	3000	
	Arm length	1600	1900
A	Max. Digging reach	6150	6450
A'	Max. Digging reach on ground	6020	6320
B	Max. Digging reach depth	3770	4070
B'	Max. Digging reach depth (8' level)	3380	3720
C	Max. Vertical wall digging depth	3230	3600
D	Max. Digging height	5760	5980
E	Max. Dumping height	4000	4210
F	Min. Swing radius	2375	2410

















HX65A

LIFTING CAPACITY

















 Rating over-front  Rating over-side or 360 degrees

HX65A

















3.0 m boom, 1.6 m arm equipped with 285kg counter weight and 400mm tracks

Lift-point height m	Lift-point radius																At max. Reach							
	2.0 m				3.0m				4.0 m				5.0 m				Capacity				Reach m			
																								
Dozer Blade	Down	Up	Down	Up	Down	Up	Down	Up	Down	Up	Down	Up	Down	Up	Down	Up	Down	Up	Down	Up	Down	Up		
4.0m	kg																							
3.0m	kg																							
2.0m	kg																							
1.0m	kg																							
0.0m	kg																							
-1.0m	kg	*3080	*3080	*3080	2840	*2750	1920	1650	1490	*1890	1260	1100	1000											
-2.0m	kg	*3610	*3610	3260	2900	*2290	1950	1670	1520															

3.0 m boom, 1.9 m arm equipped with 285kg counter weight and 400mm tracks

Lift-point height m	Lift-point radius																At max. Reach									
	1.0 m				2.0 m				3.0m				4.0 m				5.0 m				Capacity				Reach m	
																										
Dozer Blade	Down	Up	Down	Up	Down	Up	Down	Up	Down	Up	Down	Up	Down	Up	Down	Up	Down	Up	Down	Up	Down	Up	Down	Up		
5.0m	kg																									
4.0m	kg																									
3.0m	kg																									
2.0m	kg																									
1.0m	kg																									
0.0m	kg																									
-1.0m	kg	*1920	*1920	*1920	*1920	*2710	*2710	*2710	*2710	*2820	1920	1640	1490	*1920	1250	1090	990	*1380	920	810	740	*1210	830	730	670	5.01
-2.0m	kg	*3140	*3140	*3140	*3140	*4070	3990	3230	2860	*2480	1940	1660	1500	*1670	1260	1100	1000									
-3.0m	kg					*2450	*2450	*2450	*2450	*1430	*1430	*1430	*1430													

3.0 m boom, 1.9 m arm equipped with 335kg counter weight and 400mm tracks

Lift-point height m	Lift-point radius																At max. Reach									
	1.0 m				2.0 m				3.0m				4.0 m				5.0 m				Capacity				Reach m	
																										
Dozer Blade	Down	Up	Down	Up	Down	Up	Down	Up	Down	Up	Down	Up	Down	Up	Down	Up	Down	Up	Down	Up	Down	Up	Down	Up		
5.0m	kg																									
4.0m	kg																									
3.0m	kg																									
2.0m	kg																									
1.0m	kg																									
0.0m	kg																									
-1.0m	kg	*1920	*1920	*1920	*1920	*2710	*2710	*2710	*2710	*2820	1970	1680	1520	*1920	1280	1120	1020	*1380	940	830	760	*1380	940	830	760	5.01
-2.0m	kg	*3140	*3140	*3140	*3140	*4070	*4070	2930	*2480	1980	1700	1540	*1670	1290	1130	1030										
-3.0m	kg					*2450	*2450	*2450	*2450	*1430	*1430	*1430	*1430													

- Lifting capacities are based on ISO 10567.
- Lifting capacity of the HX A-series does not exceed 75% of tipping load with the machine on firm, level ground or 87% of full hydraulic capacity.
- The Lift-point is bucket pivot mounting pin on the arm (without bucket mass).
- (*) indicates load limited by hydraulic capacity.
- Caution: please be aware of the local regulations and instructions for lifting operations.

HX65A

STANDARD/OPTIONAL EQUIPMENT

MACHINE EQUIPMENT	STD	OPT
Arm 1600 mm	•	
Arm 1900 mm (long)		•
Arm safety valves	•	
Boom 3000 mm	•	
Boom safety valves	•	
Quick coupler HD Hyundai + hook push		•
Quick coupler HD Hyundai + hook slide		•
With control linkage	•	
Counterweight 235 kg	•	
Counterweight 335 kg		•
Counterweight 435 kg		•
Rotation piping prop.		•
Breaker & clamshell piping prop.	•	
Quick coupler piping		•
Dozer blade safety valve	•	
Tracks 400 mm (rubber)	•	
Tracks 400 mm + rubber pads		•
Tracks 500 mm + rubber pads		•
Tracks 380 mm (steel)		•
Tracks 450 mm (steel)		•
Roadliners 500 mm		•
Track guard 2EA		•
Proportional joysticks	•	
Adjustable heatable seat (fabric)	•	
Adjustable seat (pvc)		•
Radio & USB	•	
Standard Key		•
Smart Key + Start Button	•	
Fuel filler pump		•
Customized painting	•	
Boom light (LED)	•	
Front + Rear LED working light on cabin	•	
Beacon lamp LED		•
Rearview camera		•
Accumulator	•	
FOG Protection (top)		•
FOG Protection (front + top)		•
Travel alarm		•
Hi MATE		•
Hydr. oil - VG46	•	
Hydr. oil - tropical region VG68		•
Hydr. oil - cold region VG32		•
Bio degr. oil Panolin VG 46		•

* Standard and optional equipment may vary. Contact your HD Hyundai dealer for more information. The machine may vary according to International standards.

* The photos may include attachments and optional equipment that are not available in your area.

* Materials and specifications are subject to change without advance notice.



HD Hyundai Construction Equipment Europe nv, Hyundailaan 4,
3980 Tessenderlo, Belgium. Tel: (32) 14-56-2200 Fax: (32) 14-59-3405

Specifications and design are subject to change without notice.
Pictures of HD Hyundai Construction Equipment Europe products may
show other than standard equipment.

READY TO CHANGE YOUR WORLD?

Contact your HD Hyundai dealer.
hyundai-ce.eu/en/dealer-locator

HY-CE-00340. 08/2023. EN. ISSUE1