

COMPACT EXCAVATOR

# R25Z-9AK





**As soon as you settle into the seat of the R25Z-9AK, you're in a different world.**

Every detail has been planned around your needs. Quick, steady performance is complemented by smooth, effortless control. Its technologies have been carefully selected to offer you better comfort and safety. The rugged exterior is designed for optimal durability, while quick, easy maintenance keeps downtime to a minimum and ensures a reliable return on your investment.





# THE HYUNDAI EFFECT





## Durability/Safety

- Robust, stress-resistant upper frame
- X-type centre frame
- Durable shims & bushings
- Extended lifetime components
- Excellent visibility
- Boom/dozer cylinder cover

## Productivity

- Advanced hydraulic system
- Swing boom function
- Various piping options
- Excellent break out forces
- Compact design: zero tail swing

**ENTER  
A WORLD  
WHERE  
ANYTHING  
IS POSSIBLE**





## Comfort

- Spacious cabin
- Ergonomic soft grip joysticks
- Centralised monitoring system with warning indicators
- Mechanical suspension seat with seat belt
- Armrests
- Radio & MP3-player



## Serviceability

- Wide opening hood & covers
- Easy-to-serve air cleaner
- Centralised grease fittings
- Long-life hydraulic oil and filters



# PROTECTION FOR YOU, YOUR CO-WORKERS AND YOUR EQUIPMENT

Details can make a big difference when it comes to safety. The R25Z-9AK features a range of innovations to offer extra protection for you and your surroundings. The zero tail swing ensures that you can work safely and confidently in confined spaces, close to walls, on roadways or in urban areas. All-round visibility is maximised, whether you choose the cabin model with its large windows and narrow pillars, or an open canopy. A calm, accident-free worksite creates better peace of mind and helps you to work more productively. This is all part of the Hyundai Effect.







◀ The operator is protected by a **robust cabin structure**, built using strong, slim tubing to optimise both sturdiness and visibility. The canopy and cabin frame comply with international TOPS, ROPS and FOG standards.

◀ A **safety lever** is installed to prevent unintentional activation of the hydraulic attachments. When the safety lever is positioned upright, hydraulic functions are disabled.

◀ An array of **gauges and warning indicators** are displayed on the monitor. The monitoring system allows you to check machine status at a glance and includes an hour meter, oil pressure lamp, battery change lamp, engine coolant temperature gauge and fuel gauge.

“The clear view from the cabin really helps when I’m working on busy sites and zero tail swing gives me extra confidence when I’m working in tight spaces.”

The **boom swing** function is designed for safe, efficient work in congested residential and urban areas. The boom can be offset to the left or right within an operating range.

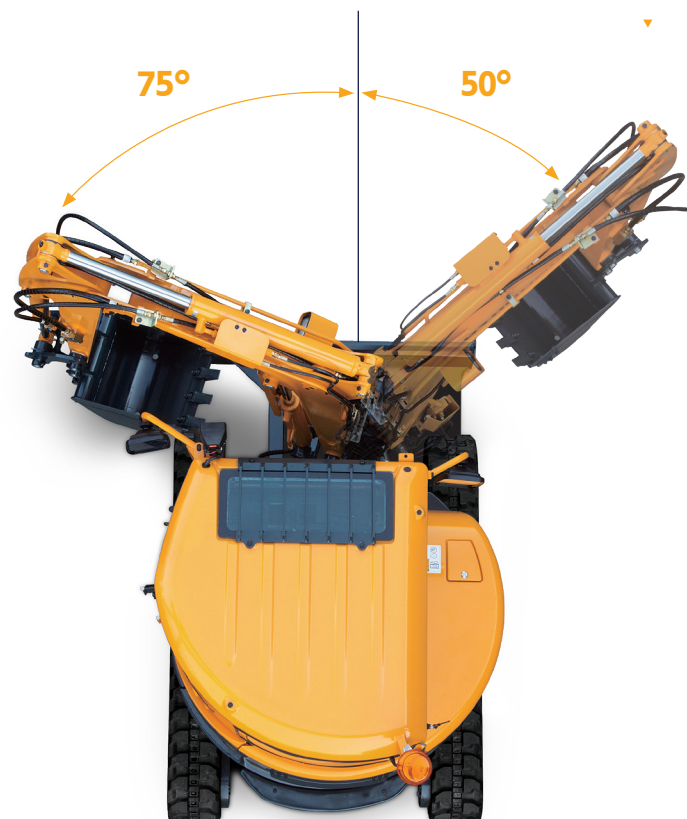



# A CABIN DESIGNED AROUND YOU

The cabin of the R25Z-9AK was designed to provide every operator with a pleasant, productive and stress-free working environment. This is achieved through a combination of low noise and vibration, ergonomic comfort and easy control. The seat, console and armrests can be easily adjusted to suit your preferred operating position, while all control devices are conveniently placed to help you work more efficiently. The overall design places you right at the centre of the Hyundai Effect, with a world of convenience and control at your fingertips.

"There's plenty of space  
and everything I need is  
right where I need it!"





The left- and right-hand **control levers** are located for maximum convenience. The joysticks have enough space for additional option switches. An optional **pattern change valve** enables easy adaptation of the joystick control pattern.



The left-side console can be tilted, making it easier to enter and exit the cabin.



The right-hand console features different-sized **cupholders** for storing large and small drinks. A **lockable storage box** is installed under the seat to hold your belongings.



The **travel, boom offset and attachment pedals** are configured for maximum comfort. The pedals can be folded in to create extra foot space.

The **slidable front window** (cabin model only) is easy to open and is held safely in the open position.

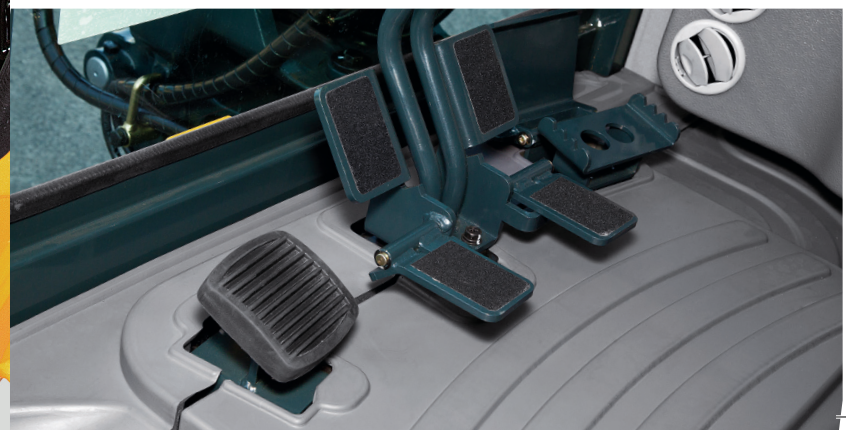



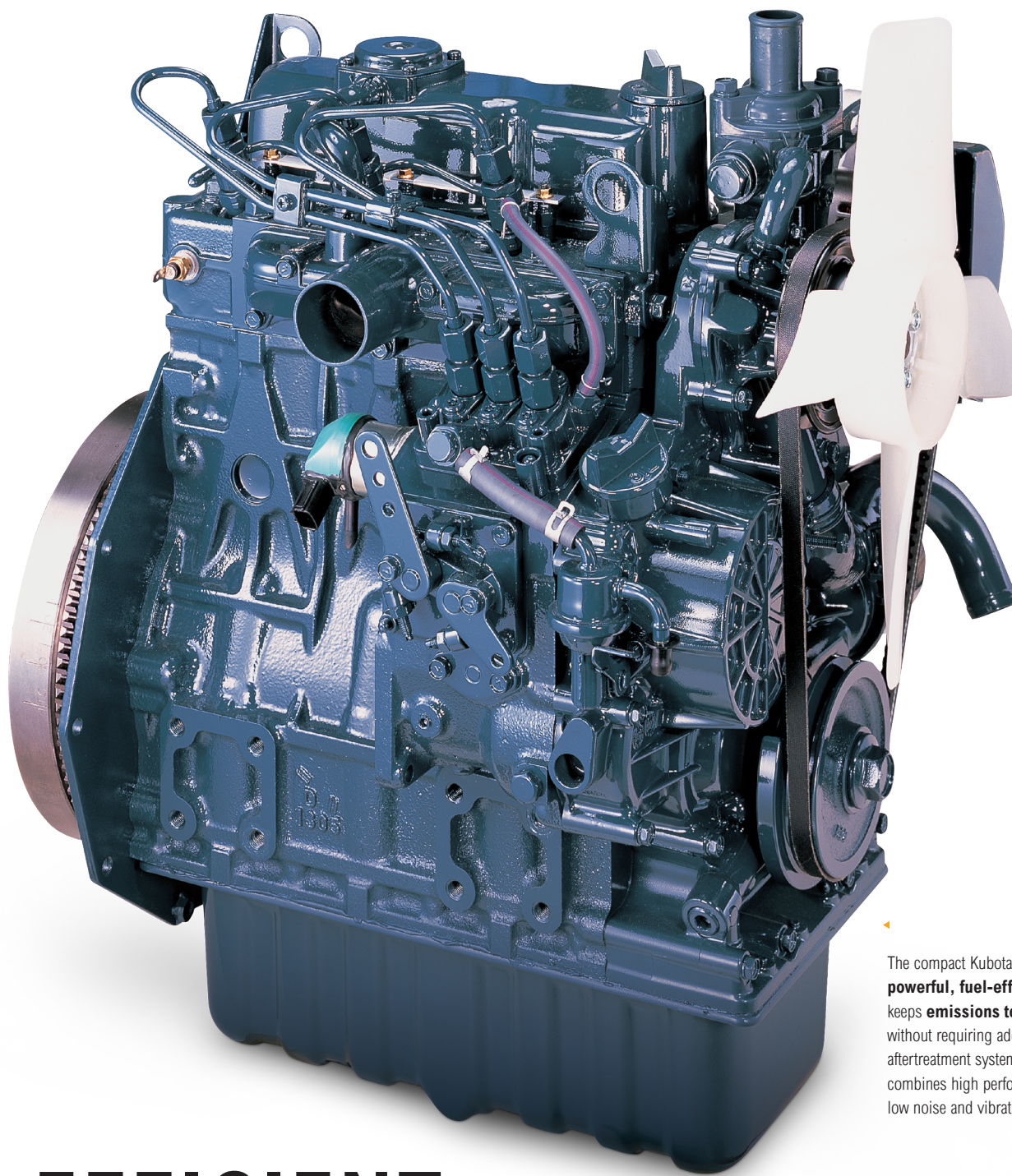

The compact Kubota engine is **powerful, fuel-efficient** and keeps **emissions to a minimum** without requiring additional aftertreatment systems. The engine combines high performance with low noise and vibration.

# EFFICIENT PERFORMANCE IN LIMITED- SPACE ENVIRONMENTS





Developed for maximum productivity, the R25Z-9AK has a compact design and zero tail swing radius to allow efficient operation in confined spaces. Its robust, eco-friendly Kubota engine is powerful, reliable and fuel-efficient, while the hydraulic system enables fast operation combined with high controllability. The result is a versatile and dependable workhorse that helps you to optimise performance and economy every day, on a broad range of jobs.

The **large dozer blade** makes the excavator more versatile as well as improving efficiency and stability on the job.



The **selector valve** makes it easy to select single acting piping (for a breaker) or double acting piping (for a clamshell). It is placed on the front side of the fuel tank for quick access and control.

There's no need for a truck to transport the R25Z-9AK between jobs. It can be moved on a **small trailer**, with an ordinary car driver's licence.

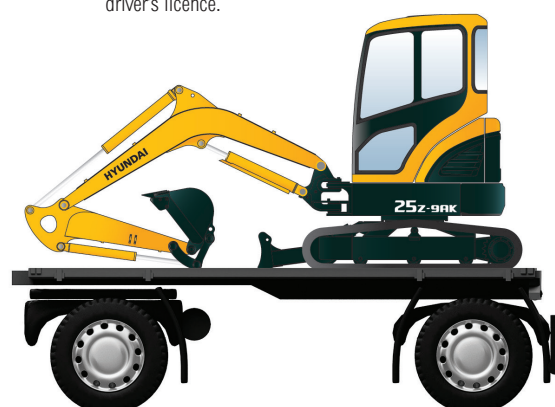



# MAXIMUM UPTIME TO PROTECT YOUR PROFITS





You need to know that the investment you make today will create a lasting return for your business. That's why we prioritised reliability at every development stage of the R25Z-9AK, from design to manufacturing and testing. The frame structures are reinforced for a long service life and resistance to tough working conditions. The pins, bushings and shims are designed for durability, while maintenance intervals are extended to keep downtime to a minimum and reduce your operating costs.

The upper **frame structure** is designed to absorb high external stress. An **X-type centre frame and reinforced box section track frame** provide exceptional strength and durability.



The **robust cab structure** is built using integrally welded slow-stress, high-strength steel to form a tough, durable upper and lower frame. Structural integrity has been tested using FEM (Finite Elements Method) analysis and long-term durability tests.



- ◀ All components are selected for **extended service intervals**, low operating costs and minimal machine downtime. This includes bushings with prolonged lube intervals (250 hrs), wear-resistant, noise-reducing polymer shims and long-life hydraulic filters (1000 hrs) and hydraulic oil (5000 hrs). Efficient cooling systems and integrated preheating systems further enhance performance and durability.

**“Every component and material has been selected with durability in mind, so there's very little downtime for maintenance or repairs.”**



- ◀ The standard **boom cylinder cover** and **dozer cylinder cover** provide additional protection.



"Everything's easy to reach and maintenance tasks are so simple that they're a pleasure rather than a chore."





# EASY SERVICING FOR TROUBLE-FREE OWNERSHIP

Working to a busy schedule, you need equipment that runs smoothly and can be easily maintained. The R25Z-9AK is designed for fast, easy servicing and monitoring with convenient access to important servicing points.

Wide opening doors, covers and hoods provide **easy access** for servicing tasks.

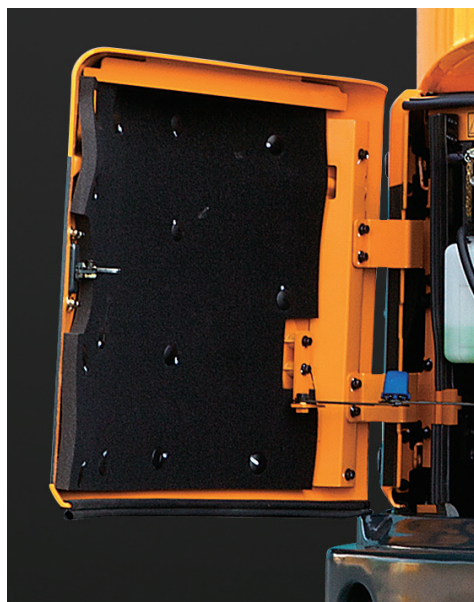

The lubrication bank **centralises grease fittings** for quick, easy servicing.



The durable **air cleaner** is designed for convenient maintenance.





# FOCUSED TECHNOLOGIES FOR THE RESULTS YOU WANT





Every Hyundai compact excavator is designed to create better conditions for operators and deliver the ultimate ownership experience. Every detail is carefully fine-tuned to match your needs in the field, including better safety and comfort, higher productivity, maximum uptime and easy servicing. It's all part of the Hyundai Effect.

See more at [www.hyundai.eu/en](http://www.hyundai.eu/en)





# SPECIFICATIONS

ENGINE			
Maker / Model		Kubota D1305	
Type		4 Cycle Diesel engine, in line, water cooled	
Rated flywheel horse power	SAE	J1995 (gross)	24.9 HP ( 18.5 kW) / 2,350 rpm
		J1349 (net)	23.2 HP ( 17.3 kW) / 2,350 rpm
	DIN	6271/1 (gross)	25.2 PS ( 18.5 kW) / 2,350 rpm
		6271/1 (net)	23.5 PS ( 17.3 kW) / 2,350 rpm
Max. torque		8.3 kgf.m (60.17 lbf.ft) / 1,600 rpm	
Bore × stroke		78 mm x 88 mm (3.07" x 3.46")	
Piston displacement		1,261 cc (76.9 in3)	
Batteries		12 V - 80 Ah	
Starting motor		12 V - 1.4 kW	
Alternator		12 V - 40 A	

HYDRAULIC SYSTEM	
<b>MAIN PUMP</b>	
Type	Variable displacement piston pumps
Max. flow	2 x 27.6 + 19.6 l/min
Sub-pump for pilot circuit	Gear pump

HYDRAULIC MOTORS	
Travel	Two speed axial piston motor with counter balance valve and parking brake
Swing	Axial piston motor with automatic brake

RELIEF VALVE SETTING	
Implement circuits	220 Kg/cm <sup>2</sup> (3,130 psi)
Travel	220 Kg/cm <sup>2</sup> (3,130 psi)
Swing circuit	175 Kg/cm <sup>2</sup> (2,489 psi)
Pilot circuit	30 Kg/cm <sup>2</sup> (430 psi)
Service valve	Installed

HYDRAULIC CYLINDERS	
No. of cylinder bore × stroke	Boom: 75 x 565 mm (3.0" x 22.2")
	Arm: 70 x 500 mm (2.8" x 19.7")
	Bucket: 55 x 420 mm (2.16" x 16.5")
	Boom swing: 75 x 400 mm (3.0" x 15.7")
	Dozer blade: 85 x 140 mm (3.3" x 5.5")

OPERATOR'S CAB	
Noise Levels (dynamic value)	Outside cabin - LwA: 94dB
	Inside cabin - LpA: 75dB

COOLANT & LUBRICANT CAPACITY			
	liter	US gal	UK gal
Fuel tank	30	7.9	6.6
Engine coolant	5.0	1.3	1.0
Engine oil	5.9	1.6	1.3
Hydraulic tank	27	7.1	5.9

TRAVEL LEVERS	
Traveling and steering : Two levers with foldable pedals.	

HYDRAULIC CONTROLS	
Pilot control	Two joysticks with one safety lever (LH): Swing and arm, (RH): Boom and bucket with horn (ISO)
Engine throttle	Mechanical, cable type

SWING SYSTEM	
Swing motor	Axial piston motor
Swing reduction	Planetary gear reduction
Swing bearing lubrication	Grease-bathed
Swing brake	Wet disc
Swing speed	9.1 rpm

DRIVES & BRAKES	
Max. travel speed (high) / (low)	4.3 km/h / 2.4 km/h ((2.7 mph) / (1.6 mph))
Maximum traction force	2.4 ton
Maximum gradeability	30°
Parking brake	Wet disc

DIGGING FORCE (ISO)	
Bucket	2,150 kgf
	21.1 kN
	4,740 lbf
Arm [Long Arm]	1,490 [1,310] kgf
	14.6 [12.8] kN
	3,280 [2,890] lbf

OPERATING WEIGHT (APPROXIMATE)		
Operating weight, including 1,945 mm (6' 5") boom, 1,120 mm (3' 8") arm, SAE heaped 0.07 m <sup>3</sup> (0.1 yd <sup>3</sup> ) excavator bucket, lubricant, coolant, full fuel tank, full hydraulic tank and all standard equipments.		
<b>OPERATING WEIGHT</b>		
Shoe Width		Rubber shoe 250 mm (10")
Operating Weight	Cabin	2,580 kg (5,690 lb)
	Canopy	2,430 kg (5,360 lb)
Ground Pressure	Cabin	0.32 kg/cm <sup>2</sup> (4.6 psi)
	Canopy	0.30 kg/cm <sup>2</sup> (4.34 psi)

UNDERCARRIAGE	
X-leg type center frame is integrally welded with reinforced box-section track frames. The undercarriage includes lubricated rollers, track adjusters with shock absorbing springs and sprockets and rubber shoes.	
Center frame	X-leg type
Track frame	Pentagonal box type
No. of carrier roller on each side	1
No. of track roller on each side	3



# DIMENSIONS & WORKING RANGE

## DIMENSIONS R25Z-9AK

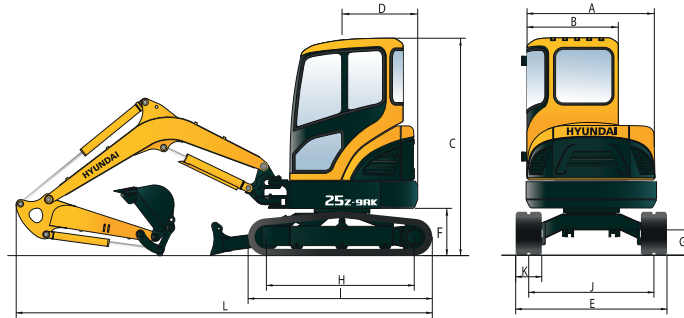

Unit : mm (ft.in)

A	Overall width of upper structure	1,485 (4' 10")
B	Overall width of cab	1,050 (3' 5")
C	Overall height of cab	2,500 (8' 2")
D	Tail swing radius - standard counterweight	775 (2' 7")
D'	Tail swing radius - additional counterweight	875 (2' 10")
E	Overall width	1,500 (4' 11")
F	Clearance under counterweight	510 (1' 6.7")
G	Ground clearance	290 (11")
H	Tumbler distance	1,490 (4' 11")
I	Track length	1,910 (6' 3")

J	Track gauge	1,250 (4' 1")
K	Track shoe width	250 (10")
L	Overall length - Standard Arm	4,030 (13' 3")
	Overall length - Long Arm	4,100 (13' 5")

## WORKING RANGE R25Z-9AK

Unit : mm (ft.in)

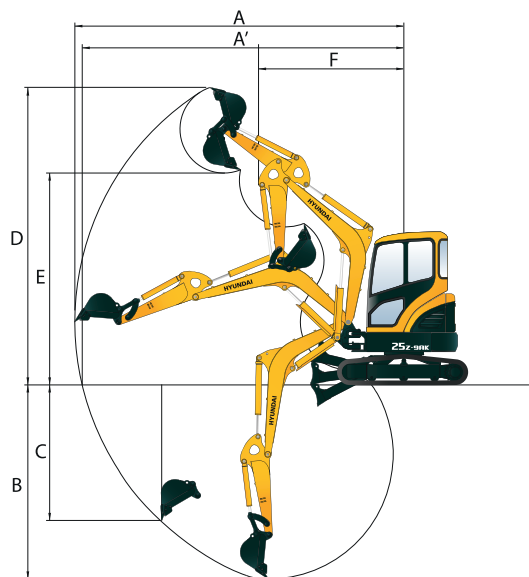

	Boom length	1,945 (6' 5")
	Arm length	1,120 (3' 8") *1,350 (4' 5")
A	Max. digging reach	4,480 (14' 8") *4,680 (15' 4")
A'	Max. digging reach on ground	4,340 (14' 3") *4,540 (14' 11")
B	Max. digging depth	2,420 (7' 11") *2,645 (8' 8")
C	Max. vertical wall digging depth	1,460 (4' 9") *1,605 (5' 3")
D	Max. digging height	4,150 (13' 7") *4,235 (13' 11")
E	Max. dumping height	2,930 (9' 7") *3,030 (9' 11")
F	Min. front swing radius	1,980 (6' 6") *1,970 (6' 6")

\* Long arm



# LIFTING CAPACITY

Rating over-front Rating over-side or 360 degrees

## R25Z-9AK

Boom : 1.945 m (6' 5") / Arm : 1.12 m (3' 8") / Bucket : 0.07 m<sup>3</sup> (0.01 yd<sup>3</sup>) SAE heaped / Dozer Down / 250 mm (9.8") Rubber track / Cabin Type / Standard counterweight

Load point height m (ft)		Load Radius								At max. reach		
		2.0 m(5 ft)		2.5 m(10 ft)		3.0 m(10 ft)		3.5 m(10 ft)		Capacity		Reach m (ft)
3.5 m (10 ft)	kg lb									*560 *1230	450 990	3.07 (10.1)
3.0 m 10 ft	kg lb					*590 *1300	460 1010			*570 *1260	340 750	3.59 (11.8)
2.5 m 10 ft	kg lb					*590 *1300	460 1010	*600 *1320	350 770	*590 *1300	290 640	3.92 (12.9)
2.0 m 5 ft	kg lb			*670 *1480	610 1340	*650 *1430	450 990	*650 *1430	350 770	*600 *1320	260 570	4.13 (13.5)
1.5 m 5 ft	kg lb	*1180 *2600	860 1900	*890 *1960	590 1300	*770 *1700	450 990	*700 *1540	340 750	*620 *1370	240 530	4.24 (13.9)
1.0m 5 ft	kg lb	*1760 *3880	800 1760	*1150 *2540	560 1230	*900 *1980	420 930	*770 *1700	330 730	*640 *1410	240 530	4.26 (14.0)
0.5 m 0 ft	kg lb	*1750 *3860	770 1700	*1340 *2950	540 1190	*1010 *2230	410 900	*830 *1830	320 710	*660 *1460	240 530	4.19 (13.7)
Ground Line	kg lb	*1990 *4390	760 1680	*1430 *3150	530 1170	*1070 *2360	400 880	*850 *1870	320 710	*680 *1500	260 570	4.04 (13.3)
-0.5 m -0 ft	kg lb	*6890 *15190	*6890 *15190	*1420 *3130	530 1170	*1060 *2340	400 880	*820 *1810	320 710	*690 *1520	290 640	3.78 (12.4)
-1.0 m -5 ft	kg lb	*1810 *3990	770 1700	*1290 *2840	530 1170	*960 *2120	400 880			*690 *1520	350 770	3.36 (11.0)
-1.5 m -5 ft	kg lb	*6890 *15190	*6890 *15190	*990 *2180	540 1190					*610 *1340	500 1100	2.67 (8.8)
-2.5 m -10 ft	kg lb	*1410 *3110	780 1720							*480 *1060	370 820	3.38 (11.1)

Boom : 1.945 m (6' 5") / Arm : 1.12 m (3' 8") / Bucket : 0.07 m<sup>3</sup> (0.01 yd<sup>3</sup>) SAE heaped / Dozer Up / 250 mm (9.8") Rubber track / Cabin Type / Standard counterweight

Load point height m (ft)		Load Radius								At max. reach				
		2.0 m(5 ft)		2.5 m(10 ft)		3.0 m(10 ft)		3.5 m(10 ft)		4.0 m(15 ft)		Capacity		Reach m (ft)
3.5 m (10 ft)	kg lb											*500 *1100	380 840	3.39 (11.1)
3.0 m 10 ft	kg lb											*510 *1120	300 660	3.85 (12.6)
2.5 m 10 ft	kg lb							*540 *1190	350 770			*530 *1170	260 570	4.15 (13.6)
2.0 m 5 ft	kg lb					*550 *1210	450 990	*570 *1260	350 770			*550 *1210	240 530	4.34 (14.2)
1.5 m 5 ft	kg lb			*740 *1630	600 1320	*670 *1480	440 970	*630 *1390	340 750	*610 *1340	270 600	*570 *1260	220 490	4.44 (14.6)
1.0m 5 ft	kg lb	*1480 *3260	820 1810	*1010 *2230	570 1260	*820 *1810	430 950	*710 *1570	330 730	*650 *1430	260 570	*590 *1300	220 490	4.46 (14.6)
0.5 m 0 ft	kg lb	*1930 *4250	780 1720	*1250 *2760	550 1210	*950 *2090	410 900	*790 *1740	320 710	*680 *1500	260 570	*610 *1340	220 490	4.40 (14.4)
Ground Line	kg lb	*2020 *4450	760 1680	*1390 *3060	530 1170	*1040 *2290	400 880	*840 *1850	310 680			*630 *1390	230 510	4.25 (13.9)
-0.5 m -0 ft	kg lb	*2090 *4610	750 1650	*1430 *3150	520 1150	*1070 *2360	390 860	*840 *1850	310 680			*660 *1460	250 550	4.01 (13.2)
-1.0 m -5 ft	kg lb	*1950 *4300	750 1650	*1360 *3000	520 1150	*1020 *2250	390 860					*670 *1480	300 660	3.64 (11.9)
-1.5 m -5 ft	kg lb	*1650 *3640	760 1680	*1160 *2560	530 1170							*660 *1460	400 880	3.06 (10.0)
-2.0 m -5 ft	kg lb	*1040 *2290	790 1740											
-2.5 m -10 ft	kg lb											*510 *1120	420 930	(3.07) (10.1)

- Lifting capacity is based on SAE J1097, ISO 10567.
- Lifting capacity of the Robex Series does not exceed 75% of the tipping load with the machine on firm, level ground or 87% of full hydraulic capacity.
- The load point is a hook located on the back of the bucket.
- (\*) indicates the load limited by hydraulic capacity.













# LIFTING CAPACITY













 Rating over-front  Rating over-side or 360 degrees

## R25Z-9AK

Boom : 1.945 m (6' 5") / Arm : 1.35 m (4' 5") / Bucket : 0.07 m<sup>3</sup> (0.01 yd<sup>3</sup>) SAE heaped / Dozer Down / 250 mm (9.8") Rubber track / Cabin Type / Standard counterweight

Load point height m (ft)	Load Radius								At max. reach			
	2.0 m(5 ft)		2.5 m(10 ft)		3.0 m(10 ft)		3.5 m(10 ft)		Capacity		Reach m (ft)	
												
3.5 m (10 ft)	kg lb									440 970	440 970	3.07 (10.1)
3.0 m 10 ft	kg lb					450 990	450 990			330 730	330 730	3.59 (11.8)
2.5 m 10 ft	kg lb					450 990	450 990	340 750	340 750	280 620	280 620	3.92 (12.9)
2.0 m 5 ft	kg lb			610 1340	600 1320	450 990	440 970	340 750	340 750	250 550	250 550	4.13 (13.5)
1.5 m 5 ft	kg lb	870 1920	840 1850	590 1300	580 1280	430 950	430 950	330 730	330 730	240 530	240 530	4.24 (13.9)
1.0m 5 ft	kg lb	810 1790	780 1720	560 1230	550 1210	420 930	410 900	320 710	320 710	230 510	230 510	4.26 (14.0)
0.5 m 0 ft	kg lb	780 1720	750 1650	540 1190	530 1170	400 880	400 880	320 710	320 710	240 530	240 530	4.19 (13.7)
Ground Line	kg lb	770 1700	740 1630	530 1170	520 1150	400 880	390 860	310 680	310 680	250 550	250 550	4.04 (13.3)
-0.5 m -0 ft	kg lb	770 1700	740 1630	530 1170	520 1150	390 860	390 860	310 680	310 680	280 620	280 620	3.78 (12.4)
-1.0 m -5 ft	kg lb	770 1700	750 1650	530 1170	520 1150	400 880	390 860			340 750	340 750	3.36 (11.0)
-1.5 m -5 ft	kg lb	790 1740	760 1680	540 1190	530 1170					500 1100	490 1080	2.67 (8.8)
-2.5 m -10 ft	kg lb									360 790	490 1080	3.38 (11.1)

Boom : 1.945 m (6' 5") / Arm : 1.35 m (4' 5") / Bucket : 0.07 m<sup>3</sup> (0.01 yd<sup>3</sup>) SAE heaped / DozerUp / 250 mm (9.8") Rubber track / Cabin Type / Standard counterweight

Load point height m (ft)	Load Radius								At max. reach				
	2.0 m(5 ft)		2.5 m(10 ft)		3.0 m(10 ft)		3.5 m(10 ft)		4.0 m(15 ft)		Capacity		Reach m (ft)
													
3.5 m (10 ft)	kg lb										370 820	370 820	3.39 (11.1)
3.0 m 10 ft	kg lb										290 640	290 640	3.85 (12.6)
2.5 m 10 ft	kg lb							340 750	340 750		250 550	250 550	4.15 (13.6)
2.0 m 5 ft	kg lb					450 990	440 970	340 750	340 750		250 550	230 510	4.34 (14.2)
1.5 m 5 ft	kg lb			600 1320	590 1300	440 970	430 950	330 730	330 730	260 570	260 570	220 490	4.44 (14.6)
1.0m 5 ft	kg lb	830 1830	800 1760	570 1260	560 1230	420 930	420 930	320 710	320 710	260 570	260 570	210 460	4.46 (14.6)
0.5 m 0 ft	kg lb	790 1740	760 1680	540 1190	530 1170	410 900	400 880	310 680	310 680	250 550	250 550	210 460	4.40 (14.4)
Ground Line	kg lb	770 1700	740 1630	530 1170	520 1150	390 860	390 860	310 680	310 680		220 490	230 510	4.25 (13.9)
-0.5 m -0 ft	kg lb	760 1680	730 1610	520 1150	510 1120	390 860	380 840	300 660	300 660		250 550	250 550	4.01 (13.2)
-1.0 m -5 ft	kg lb	760 1680	730 1610	520 1150	510 1120	390 860	380 840				290 640	290 640	3.64 (11.9)
-1.5 m -5 ft	kg lb	770 1700	740 1630	530 1170	510 1120						390 860	390 860	3.06 (10.0)
-2.0 m -5 ft	kg lb	790 1740	760 1680										
-2.5 m -10 ft	kg lb										410 900	410 900	(3.07) (10.1)



<b>STANDARD EQUIPMENT R25Z-9AK</b>
<b>CERTIFIED CABIN</b>
ROPS (Roll-over protective structure)
FOG (Falling object guard)
TOPS (Tip-over protective structure)
<b>ALL-WEATHER STEEL CAB WITH ALL-AROUND VISIBILITY</b>
<b>SAFETY GLASS WINDOWS</b>
<b>SLIDING FOLD-IN FRONT WINDOW</b>
<b>SLIDING SIDE WINDOW</b>
<b>LOCKABLE DOOR</b>
<b>ACCESSORY BOX</b>
<b>CENTRALISED MONITORING</b>
<b>GAUGES</b>
Fuel level gauge
Engine coolant temperature gauge
<b>WARNING LAMPS</b>
Engine oil pressure
Engine coolant temperature
Preheat engine
Low battery
Air cleaner clogging
Fuel empty
<b>DOOR AND LOCKS, ONE KEY FITS ALL</b>
<b>MECHANICAL SUSPENSION SEAT WITH SEAT BELT</b>
<b>CONSOLE BOX TILTING SYSTEM (LH.)</b>
<b>ACCUMULATOR, WORK EQUIPMENT LOWERING</b>
<b>TRAVEL ALARM</b>
<b>WORKING LIGHT BOOM</b>
<b>ELECTRIC HORN</b>
<b>BATTERY (1 X 12 V X 80 AH)</b>
<b>BATTERY MASTER SWITCH</b>
<b>AUTOMATIC SWING BRAKE</b>
<b>REMOVABLE RESERVOIR TANK</b>
<b>WATER SEPARATOR, FUEL LINE</b>
<b>MONO BOOM (1.945 M; 6' 5")</b>
<b>ARM (1.12 M; 3' 8")</b>
<b>RUBBER TRACK (250 MM; 10")</b>
<b>SINGLE ACTING PIPING (BREAKER, ETC)</b>
<b>DOUBLE ACTING PIPING (CLAMSHELL, ETC)</b>
<b>BUCKET 0.07 M<sup>3</sup></b>

<b>OPTIONAL EQUIPMENT R25Z-9AK</b>
<b>CERTIFIED CANOPY</b>
<b>BEACON LAMP</b>
<b>QUICK COUPLER</b>
<b>LONG ARM (1.35 M; 4' 5")</b>
<b>HEATER &amp; DEFROSTER</b>
<b>RADIO / USB PLAYER</b>
<b>PATTERN CHANGE VALVE</b>
<b>ADDITIONAL COUNTERWEIGHT</b>
<b>QUICK COUPLER PIPING</b>
<b>DOUBLE ACTING PROPORTIONAL PIPING</b>
<b>ROTATION PROPORTIONAL PIPING</b>
<b>BIO OIL</b>
<b>CUSTOMIZED PAINTING</b>
<b>CABIN LIGHT</b>
<b>CENTRAL GREASING SYSTEM</b>

\* Standard and optional equipment may vary. Contact your Hyundai dealer for more information. The machine may vary according to International standards.  
 \* The photos may include attachments and optional equipment that are not available in your area.  
 \* Materials and specifications are subject to change without advance notice.  
 \* All imperial measurements rounded off to the nearest pound or inch.







Specifications and design are subject to change without notice. Pictures of Hyundai Construction Equipment Europe products may show other than standard equipment.

Hyundai Construction Equipment Europe nv, Hyundailaan 4, 3980 Tessenderlo, Belgium. Tel: (32) 14-56-2200 Fax: (32) 14-59-3405

EN - 2016.02 Rev 1

**Ready to experience the Hyundai Effect?**

**Contact your Hyundai dealer.**

**[www.hyundai.eu/dealer](http://www.hyundai.eu/dealer)**

 **HYUNDAI**  
CONSTRUCTION EQUIPMENT